

# MMBT6517L, NSVMMBT6517L

## High Voltage Transistor

### NPN Silicon

#### Features

- NSV Prefix for Automotive and Other Applications Requiring Unique Site and Control Change Requirements; AEC-Q101 Qualified and PPAP Capable
- These Devices are Pb-Free, Halogen Free/BFR Free and are RoHS Compliant

#### MAXIMUM RATINGS

Rating	Symbol	Value	Unit
Collector – Emitter Voltage	$V_{CEO}$	350	V
Collector – Base Voltage	$V_{CBO}$	350	V
Emitter – Base Voltage	$V_{EBO}$	5.0	V
Base Current	$I_B$	25	mA
Collector Current – Continuous	$I_C$	100	mA

#### THERMAL CHARACTERISTICS

Characteristic	Symbol	Max	Unit
Total Device Dissipation FR-5 Board (Note 1) $T_A = 25^\circ\text{C}$ Derate above $25^\circ\text{C}$	$P_D$	225 1.8	mW mW/ $^\circ\text{C}$
Thermal Resistance, Junction-to-Ambient	$R_{\theta JA}$	556	$^\circ\text{C}/\text{W}$
Total Device Dissipation Alumina Substrate, (Note 2) $T_A = 25^\circ\text{C}$ Derate above $25^\circ\text{C}$	$P_D$	300 2.4	mW mW/ $^\circ\text{C}$
Thermal Resistance, Junction-to-Ambient	$R_{\theta JA}$	417	$^\circ\text{C}/\text{W}$
Junction and Storage Temperature	$T_J, T_{stg}$	-55 to +150	$^\circ\text{C}$

Stresses exceeding Maximum Ratings may damage the device. Maximum Ratings are stress ratings only. Functional operation above the Recommended Operating Conditions is not implied. Extended exposure to stresses above the Recommended Operating Conditions may affect device reliability.

1. FR-5 =  $1.0 \times 0.75 \times 0.062$  in.
2. Alumina =  $0.4 \times 0.3 \times 0.024$  in. 99.5% alumina.



ON Semiconductor®

<http://onsemi.com>

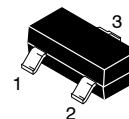
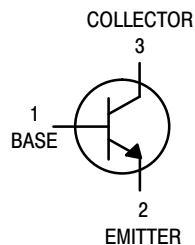

SOT-23 (TO-236AB)  
CASE 318  
STYLE 6

#### MARKING DIAGRAM

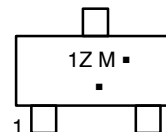

1Z = Device Code  
M = Date Code\*  
■ = Pb-Free Package

(Note: Microdot may be in either location)

\*Date Code orientation and/or overbar may vary depending upon manufacturing location.

#### ORDERING INFORMATION

Device	Package	Shipping†
MMBT6517LT1G	SOT-23 (Pb-Free)	3000 / Tape & Reel
MMBT6517LT3G	SOT-23 (Pb-Free)	10,000 / Tape & Reel
NSVMMBT6517LT1G	SOT-23 (Pb-Free)	3,000 / Tape & Reel

†For information on tape and reel specifications, including part orientation and tape sizes, please refer to our Tape and Reel Packaging Specifications Brochure, BRD8011/D.

# MMBT6517L, NSVMMBT6517L

## ELECTRICAL CHARACTERISTICS (T<sub>A</sub> = 25°C unless otherwise noted)

Characteristic	Symbol	Min	Max	Unit
<b>OFF CHARACTERISTICS</b>				
Collector – Emitter Breakdown Voltage (I <sub>C</sub> = 1.0 mA)	V <sub>(BR)CEO</sub>	350	–	V
Collector – Base Breakdown Voltage (I <sub>C</sub> = 100 μA)	V <sub>(BR)CBO</sub>	350	–	V
Emitter – Base Breakdown Voltage (I <sub>E</sub> = 10 μA)	V <sub>(BR)EBO</sub>	6.0	–	V
Collector Cutoff Current (V <sub>CB</sub> = 250 V)	I <sub>CBO</sub>	–	50	nA
Emitter Cutoff Current (V <sub>EB</sub> = 5.0 V)	I <sub>EBO</sub>	–	50	nA
<b>ON CHARACTERISTICS</b>				
DC Current Gain (I <sub>C</sub> = 1.0 mA, V <sub>CE</sub> = 10 V) (I <sub>C</sub> = 10 mA, V <sub>CE</sub> = 10 V) (I <sub>C</sub> = 30 mA, V <sub>CE</sub> = 10 V) (I <sub>C</sub> = 50 mA, V <sub>CE</sub> = 10 V) (I <sub>C</sub> = 100 mA, V <sub>CE</sub> = 10 V)	h <sub>FE</sub>	20 30 30 20 15	– – 200 200 –	–
Collector – Emitter Saturation Voltage (Note 3) (I <sub>C</sub> = 10 mA, I <sub>B</sub> = 1.0 mA) (I <sub>C</sub> = 20 mA, I <sub>B</sub> = 2.0 mA) (I <sub>C</sub> = 30 mA, I <sub>B</sub> = 3.0 mA) (I <sub>C</sub> = 50 mA, I <sub>B</sub> = 5.0 mA)	V <sub>CE(sat)</sub>	– – – –	0.30 0.35 0.50 1.0	V
Base – Emitter Saturation Voltage (I <sub>C</sub> = 10 mA, I <sub>B</sub> = 1.0 mA) (I <sub>C</sub> = 20 mA, I <sub>B</sub> = 2.0 mA) (I <sub>C</sub> = 30 mA, I <sub>B</sub> = 3.0 mA)	V <sub>BE(sat)</sub>	– – –	0.75 0.85 0.90	V
Base – Emitter On Voltage (I <sub>C</sub> = 100 mA, V <sub>CE</sub> = 10 V)	V <sub>BE(on)</sub>	–	2.0	V
<b>SMALL-SIGNAL CHARACTERISTICS</b>				
Current Gain – Bandwidth Product (I <sub>C</sub> = 10 mA, V <sub>CE</sub> = 20 V, f = 20 MHz)	f <sub>T</sub>	40	200	MHz
Collector–Base Capacitance (V <sub>CB</sub> = 20 V, f = 1.0 MHz)	C <sub>cb</sub>	–	6.0	pF
Emitter–Base Capacitance (V <sub>EB</sub> = 0.5 V, f = 1.0 MHz)	C <sub>eb</sub>	–	80	pF

3. Pulse Test: Pulse Width = 300 μs, Duty Cycle = 2.0%.

# MMBT6517L, NSVMMBT6517L

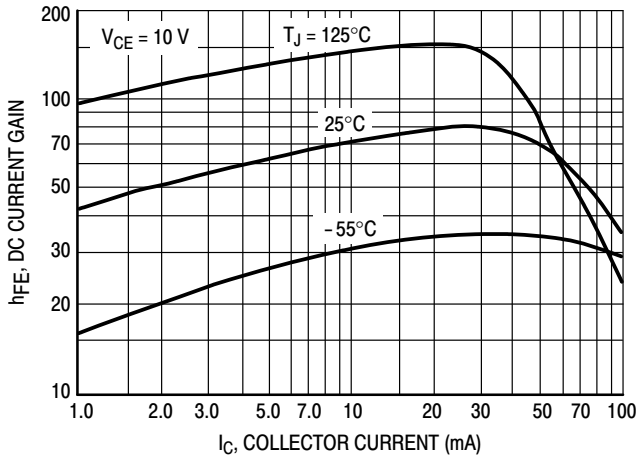

Figure 1. DC Current Gain

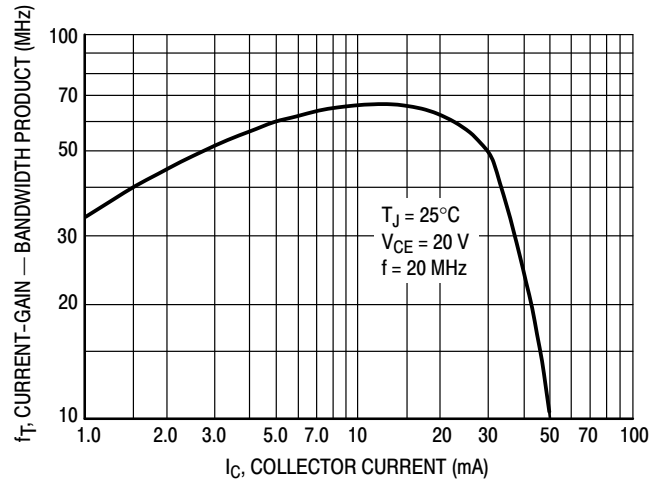

Figure 2. Current-Gain — Bandwidth Product

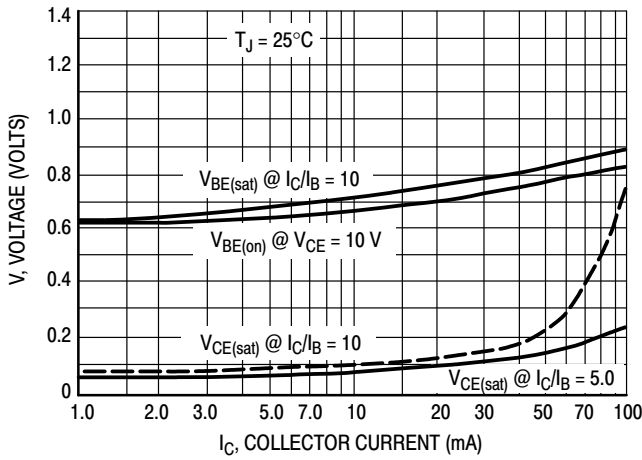

Figure 3. "On" Voltages

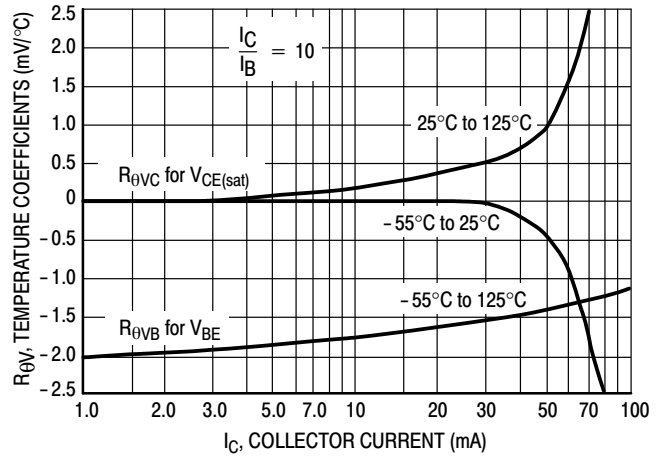

Figure 4. Temperature Coefficients

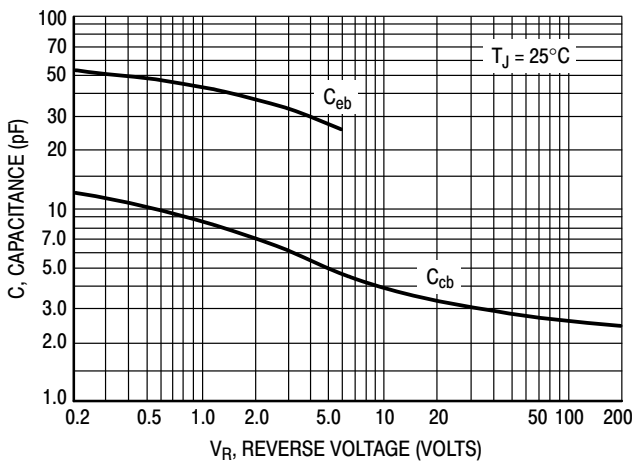

Figure 5. Capacitance

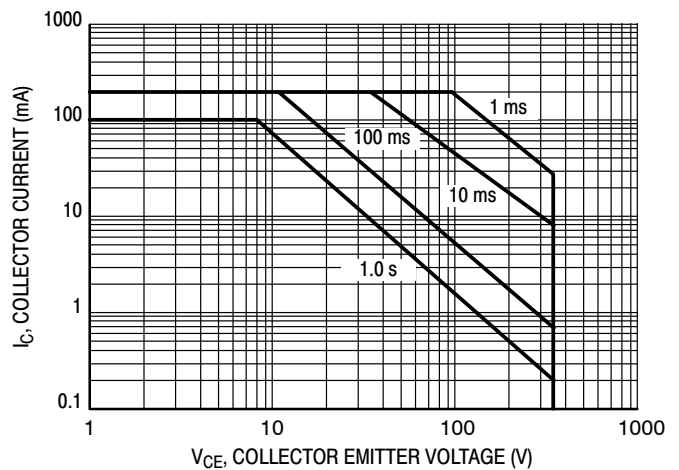

Figure 6. Safe Operating Area

# MMBT6517L, NSVMMBT6517L

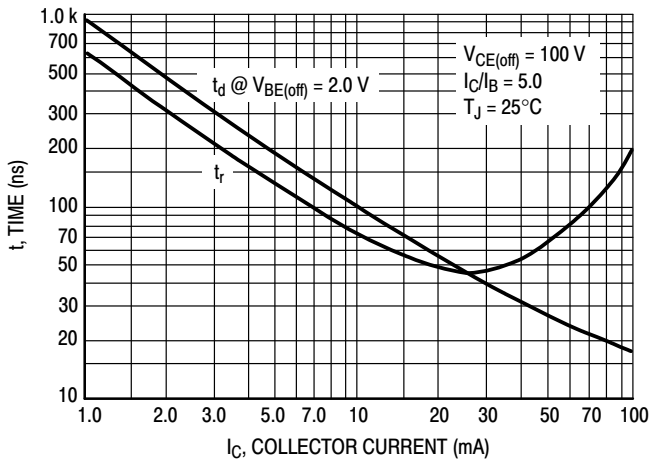

Figure 7. Turn-On Time

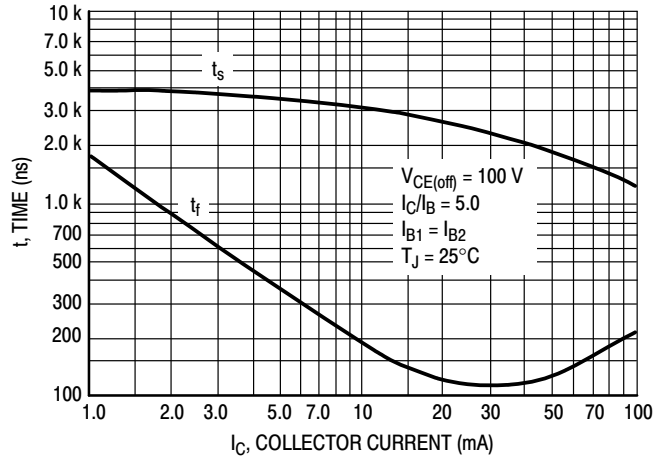

Figure 8. Turn-Off Time

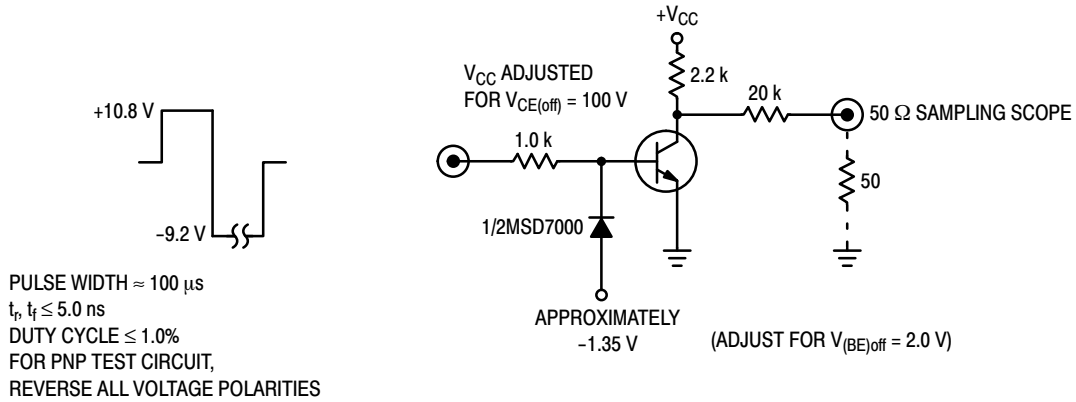

Figure 9. Switching Time Test Circuit

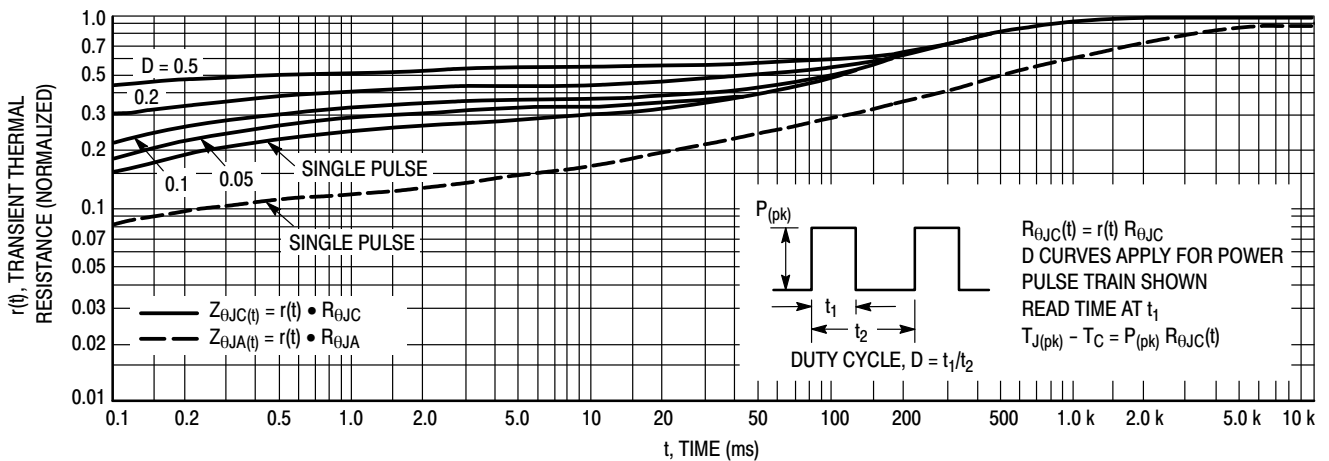
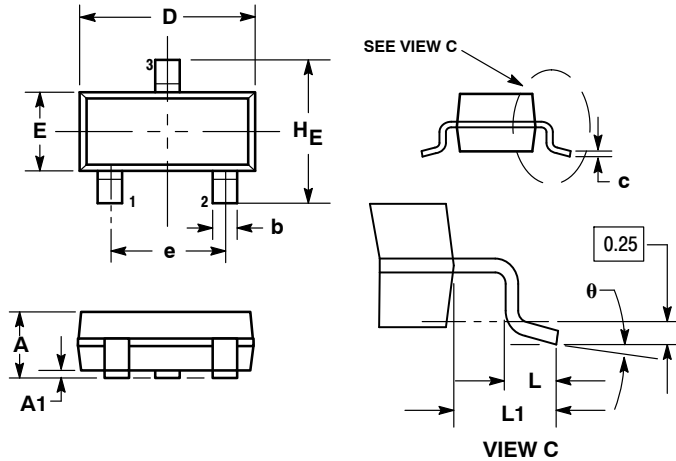

Figure 10. Thermal Response

# MMBT6517L, NSVMMBT6517L

## PACKAGE DIMENSIONS

SOT-23 (TO-236)  
CASE 318-08  
ISSUE AP



NOTES:

1. DIMENSIONING AND TOLERANCING PER ANSI Y14.5M, 1982.
2. CONTROLLING DIMENSION: INCH.
3. MAXIMUM LEAD THICKNESS INCLUDES LEAD FINISH THICKNESS. MINIMUM LEAD THICKNESS IS THE MINIMUM THICKNESS OF BASE MATERIAL.
4. DIMENSIONS D AND E DO NOT INCLUDE MOLD FLASH, PROTRUSIONS, OR GATE BURRS.

DIM	MILLIMETERS			INCHES		
	MIN	NOM	MAX	MIN	NOM	MAX
A	0.89	1.00	1.11	0.035	0.040	0.044
A1	0.01	0.06	0.10	0.001	0.002	0.004
b	0.37	0.44	0.50	0.015	0.018	0.020
c	0.09	0.13	0.18	0.003	0.005	0.007
D	2.80	2.90	3.04	0.110	0.114	0.120
E	1.20	1.30	1.40	0.047	0.051	0.055
e	1.78	1.90	2.04	0.070	0.075	0.081
L	0.10	0.20	0.30	0.004	0.008	0.012
L1	0.35	0.54	0.69	0.014	0.021	0.029
HE	2.10	2.40	2.64	0.083	0.094	0.104
θ	0°	---	10°	0°	---	10°

STYLE 6:

1. BASE
2. EMITTER
3. COLLECTOR

### SOLDERING FOOTPRINT\*

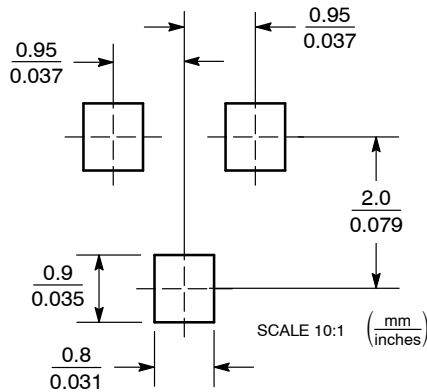

\*For additional information on our Pb-Free strategy and soldering details, please download the ON Semiconductor Soldering and Mounting Techniques Reference Manual, SOLDERRM/D.

ON Semiconductor and are registered trademarks of Semiconductor Components Industries, LLC (SCILLC). SCILLC owns the rights to a number of patents, trademarks, copyrights, trade secrets, and other intellectual property. A listing of SCILLC's product/patent coverage may be accessed at [www.onsemi.com/site/pdf/Patent-Marking.pdf](http://www.onsemi.com/site/pdf/Patent-Marking.pdf). SCILLC reserves the right to make changes without further notice to any products herein. SCILLC makes no warranty, representation or guarantee regarding the suitability of its products for any particular purpose, nor does SCILLC assume any liability arising out of the application or use of any product or circuit, and specifically disclaims any and all liability, including without limitation special, consequential or incidental damages. "Typical" parameters which may be provided in SCILLC data sheets and/or specifications can and do vary in different applications and actual performance may vary over time. All operating parameters, including "Typicals" must be validated for each customer application by customer's technical experts. SCILLC does not convey any license under its patent rights nor the rights of others. SCILLC products are not designed, intended, or authorized for use as components in systems intended for surgical implant into the body, or other applications intended to support or sustain life, or for any other application in which the failure of the SCILLC product could create a situation where personal injury or death may occur. Should Buyer purchase or use SCILLC products for any such unintended or unauthorized application, Buyer shall indemnify and hold SCILLC and its officers, employees, subsidiaries, affiliates, and distributors harmless against all claims, costs, damages, and expenses, and reasonable attorney fees arising out of, directly or indirectly, any claim of personal injury or death associated with such unintended or unauthorized use, even if such claim alleges that SCILLC was negligent regarding the design or manufacture of the part. SCILLC is an Equal Opportunity/Affirmative Action Employer. This literature is subject to all applicable copyright laws and is not for resale in any manner.

### PUBLICATION ORDERING INFORMATION

LITERATURE FULFILLMENT:  
Literature Distribution Center for ON Semiconductor  
P.O. Box 5163, Denver, Colorado 80217 USA  
Phone: 303-675-2175 or 800-344-3860 Toll Free USA/Canada  
Fax: 303-675-2176 or 800-344-3867 Toll Free USA/Canada  
Email: [orderlit@onsemi.com](mailto:orderlit@onsemi.com)

N. American Technical Support: 800-282-9855 Toll Free  
USA/Canada  
Europe, Middle East and Africa Technical Support:  
Phone: 421 33 790 2910  
Japan Customer Focus Center  
Phone: 81-3-5817-1050

ON Semiconductor Website: [www.onsemi.com](http://www.onsemi.com)  
Order Literature: <http://www.onsemi.com/orderlit>  
For additional information, please contact your local Sales Representative